

FRONT VIEW

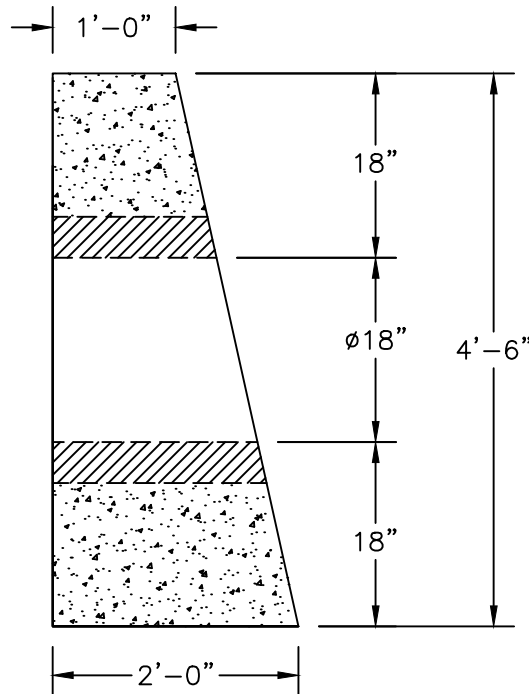

SIDE VIEW

NOTES

1. CONCRETE: FC = 4,000 PSI @ 28 DAYS MIN
2. REINFORCING STEEL: ASTM A615 GRADE #60

SHEA PRODUCT ID:
HWSNHDOT-18

PREPARED FOR:

FILE NAME: 18in PIPE NHDOT.dwg

WEIGHT (LBS):
7,000#

DRAWN BY: ARO

DATE: 06/01/18

PAGE: G11.4-3

