

FRONT VIEW

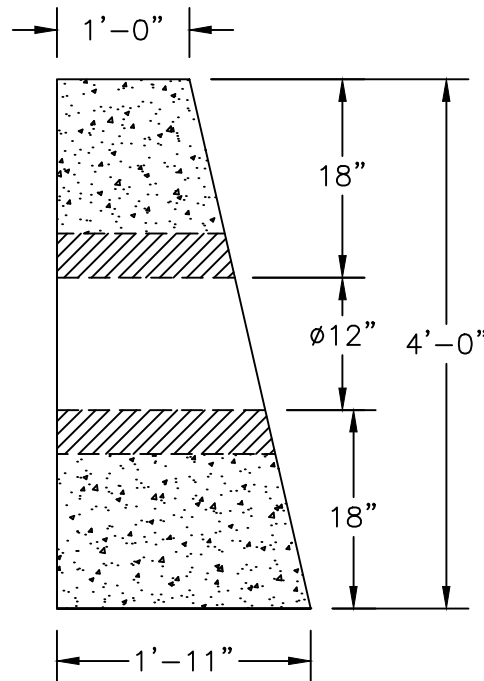

SIDE VIEW

NOTES

1. CONCRETE: FC = 4,000 PSI @ 28 DAYS MIN
2. REINFORCING STEEL: ASTM A615 GRADE #60

SHEA PRODUCT ID:
HWSNHDOT-12

PREPARED FOR:

FILE NAME:
12in PIPE NHDOT.dwg

WEIGHT (LBS):
3,880#

DRAWN BY:
ARO

DATE:
06/01/18

PAGE:
G11.4-1

