



New England's Premier Precaster!

(800) 696-SHEA (7432)

www.sheaconcrete.com

773 Salem Street • Wilmington, MA 01887 • (978) 658-2645
 87 Haverhill Road • Amesbury, MA 01913 • (978) 388-1509
 153 Cranberry Highway • Rochester, MA 02770 • (508) 291-1314
 160 Old Turnpike Road • Nottingham, NH 03290 • (603) 942-5668

Prices based on 30 mile radius of plant and do not include sales tax.

Steps		Width						Side Entry	
		4	5	6	7	8	10	4	5
1 Riser	Plain Concrete	\$575.00	\$620.00	\$660.00	\$700.00	\$920.00	N/A	\$680.00	\$755.00
	Brick Faced	\$730.00	\$810.00	\$865.00	\$925.00	\$1,175.00	N/A	N/A	N/A
	Brick & Granite	N/A	\$1,350.00	\$1,510.00	N/A	\$2,045.00	N/A	N/A	N/A
	Stone & Granite	N/A	\$1,405.00	\$1,570.00	N/A	\$2,110.00	N/A	N/A	N/A
2 Riser	Plain Concrete	\$680.00	\$745.00	\$800.00	\$870.00	\$1,095.00	\$1,235.00	\$830.00	\$925.00
	Brick Faced	\$965.00	\$1,100.00	\$1,190.00	\$1,290.00	\$1,560.00	\$1,770.00	N/A	N/A
	Brick & Granite	N/A	\$1,755.00	\$1,975.00	N/A	\$2,610.00	N/A	N/A	N/A
	Stone & Granite	N/A	\$1,870.00	\$2,095.00	N/A	\$2,740.00	N/A	N/A	N/A
3 Riser	Plain Concrete	\$795.00	\$885.00	\$955.00	\$1,050.00	\$1,280.00	\$1,480.00	\$995.00	\$1,115.00
	Brick Faced	\$1,240.00	\$1,425.00	\$1,545.00	\$1,695.00	\$1,980.00	\$2,285.00	N/A	N/A
	Brick & Granite	N/A	\$2,195.00	\$2,470.00	N/A	\$3,205.00	N/A	N/A	N/A
	Stone & Granite	N/A	\$2,380.00	\$2,665.00	N/A	\$3,420.00	N/A	N/A	N/A
4 Riser	Plain Concrete	\$925.00	\$1,035.00	\$1,120.00	\$1,245.00	\$1,475.00	\$1,735.00	\$1,175.00	\$1,310.00
	Brick Faced	\$1,540.00	\$1,780.00	\$1,935.00	\$2,130.00	\$2,435.00	\$2,830.00	N/A	N/A
	Brick & Granite	N/A	\$2,665.00	\$3,000.00	N/A	\$3,830.00	N/A	N/A	N/A
	Stone & Granite	N/A	\$2,930.00	\$3,280.00	N/A	\$4,140.00	N/A	N/A	N/A
5 Riser	Plain Concrete	\$1,065.00	\$1,195.00	\$1,300.00	\$1,455.00	\$1,685.00	\$2,005.00	\$1,360.00	\$1,525.00
	Brick Faced	\$1,880.00	\$2,170.00	\$2,355.00	\$2,595.00	\$2,920.00	\$3,410.00	N/A	N/A
	Brick & Granite	N/A	\$3,170.00	\$3,560.00	N/A	\$4,490.00	N/A	N/A	N/A
	Stone & Granite	N/A	\$3,530.00	\$3,935.00	N/A	\$4,900.00	N/A	N/A	N/A
6 Riser	Plain Concrete	\$1,215.00	\$1,370.00	\$1,490.00	\$1,675.00	\$1,905.00	\$2,285.00	\$1,565.00	\$1,745.00
	Brick Faced	\$2,250.00	\$2,595.00	\$2,810.00	\$3,100.00	\$3,435.00	\$4,025.00	N/A	N/A
	Brick & Granite	N/A	\$3,710.00	\$4,155.00	N/A	\$5,185.00	N/A	N/A	N/A
	Stone & Granite	N/A	\$4,170.00	\$4,635.00	N/A	\$5,710.00	N/A	N/A	N/A
7 Riser	Plain Concrete	N/A	\$1,555.00	\$1,690.00	\$1,905.00	N/A	N/A	N/A	\$1,980.00
	Brick Faced	N/A	\$3,050.00	\$3,300.00	\$3,630.00	N/A	N/A	N/A	N/A
	Brick & Granite	N/A	N/A	N/A	N/A	N/A	N/A	N/A	N/A
	Stone & Granite	N/A	N/A	N/A	N/A	N/A	N/A	N/A	N/A

Rails	Miscellaneous		
	42" Plat	No Plat	Side Entry
1 Riser	\$420.00	N/A	N/A
2 Riser	\$465.00	\$355.00	\$660.00
3 Riser	\$535.00	\$395.00	\$700.00
4 Riser	\$600.00	\$475.00	\$740.00
5 Riser	\$660.00	\$555.00	\$780.00
6 Riser	\$730.00	\$655.00	\$820.00
7 Riser	\$805.00	\$720.00	\$860.00

Miscellaneous	
Banking Steps	\$880.00
Angle Iron Brackets	\$90.00
Remove & Dispose of Precast Stairs (When ordering new set)	\$280.00

Platform Depth 42" Standard (60" on side entry)

Not responsible for damage beyond curb line; including lawn.

Stair Measurements may vary up to 1/2 inch.
 20% handling charge on all returned goods.
 Prices are subject to change without notice

IMPORTANT: DO NOT use salt or deicing products on stairs.

Updated September 7, 2019

Bulkheads

Prices based on 30 mile radius of plant and do not include sales tax.

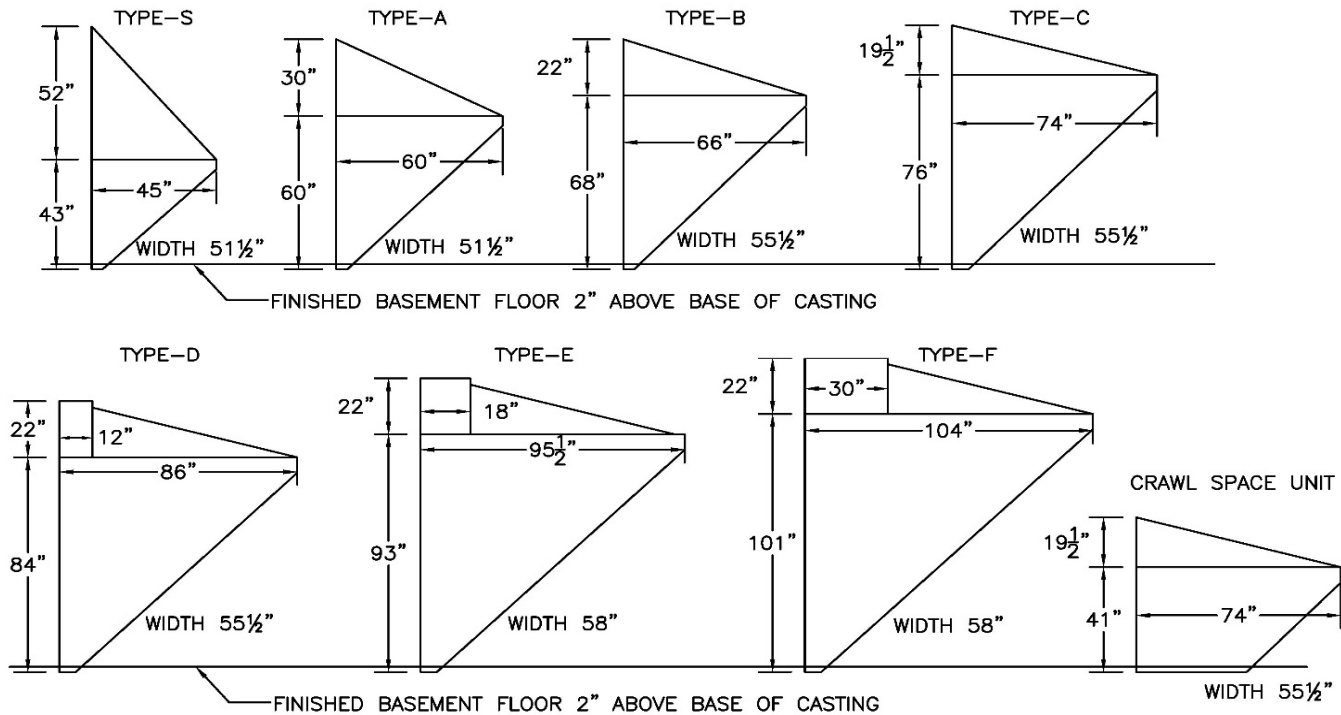

Type	Concrete Height	Concrete w/Door	Concrete Only	Door Installed	Door Only
S	43"	\$1,670.00	\$1,160.00	\$875.00	\$695.00
A	60"	\$1,550.00	\$1,170.00	\$720.00	\$590.00
B	68"	\$1,670.00	\$1,320.00	\$720.00	\$590.00
C	76"	\$1,820.00	\$1,470.00	\$750.00	\$620.00
D	84"	\$2,040.00	\$1,620.00	\$1,000.00	\$820.00
E	93"	\$2,590.00	\$2,160.00	\$1,035.00	\$855.00
F	101"	\$2,930.00	\$2,420.00	\$1,150.00	\$960.00
CRAWL	41"	\$1,820.00	\$1,470.00	\$750.00	\$620.00

Extensions

12"	\$200.00
18"	\$235.00
30"	\$340.00

Bulkhead Door Lock

Not installed \$90.00

Brackets for Block Wall

\$120.00

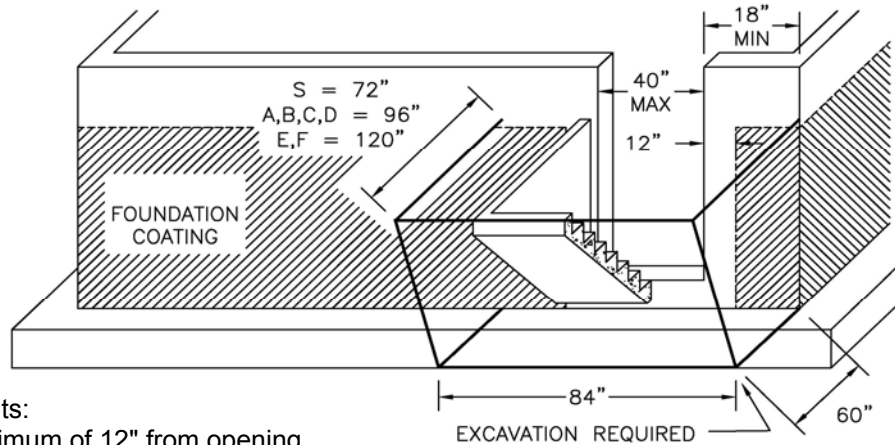

Bulkhead Installation Requirements:

- 1) Keep foundation sealer a minimum of 12" from opening.
- 2) Pour a minimum of a 11 1/2" sep in bulkhead opening as shown.
- 3) Keep a Minimum of 18" from foundation corner.
- 4) Roof drainage should be diverted away from bulkhead opening.
- 5) Perimeter drainage required.
- 6) Back fill should be clean gravel well compacted.
- 7) How to order: Determine dimension from top of footing to proposed finished grade. Refer to types available and select size to assure top of stairwell will be 2" to 6" above finished grade.

Return to job and/or work above and beyond project scope - \$125/hr
 20% handling charge on all returned goods.
 Remove and Dispose of bulkhead - \$400

Prices are subject to change without notice.
 Updated September 3, 2019